

# HELIFLEX

PREMIUM



**16x15mm | Side Bend | Single colour**

IP67 | -20 to 45deg C | Uniform dot free illumination | Silicon extrusion moulding | High UV and salt water resistance | High impact resistance

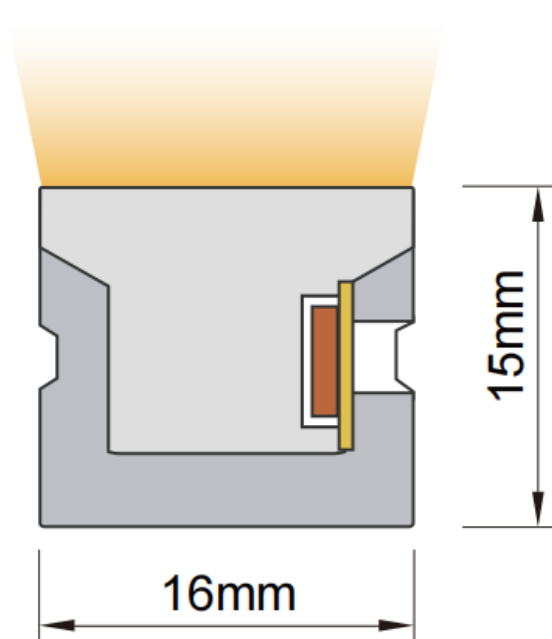

**SINGLE COLOUR  
WHITE**



**5w per metre (up to 25m powered one end)**

CODE	V	W	COLOUR	CUT (mm)	Lm/m	MAX
HFP1615SB.5.27K	24	5	2700k	50		25m
HFP1615SB.5.3K	24	5	3000k	50	240	25m
HFP1615SB.5.4K	24	5	4000k	50		25m
HFP1615SB.5.65K	24	5	6500k	50		25m

**7.2w per metre (up to 20m powered one end)**

CODE	V	W	COLOUR	CUT (mm)	Lm/m	MAX
HF1615SB.72.27K	24	7.2	2700k	50		20m
HF1615SB.72.3K	24	7.2	3000k	50	346	20m
HF1615SB.72.4K	24	7.2	4000k	50		20m
HF1615SB.72.65K	24	7.2	6500k	50		20m



**SINGLE COLOUR  
WHITE**



**10w per metre (up to 15m powered one end)**

CODE	V	W	COLOUR	CUT (mm)	Lm/m	MAX
HFP1615SB.10.27K	24	10	2700k	50		15m
HFP1615SB.10.3K	24	10	3000k	50	460	15m
HFP1615SB.10.4K	24	10	4000k	50		15m
HFP1615SB.10.65K	24	10	6500k	50		15m

**15w per metre (up to 12m powered one end)**

CODE	V	W	COLOUR	CUT (mm)	Lm/m	MAX
HF1615SB.15.27K	24	15	2700k	50		10m
HF1615SB.15.3K	24	15	3000k	50	628	10m
HF1615SB.15.4K	24	15	4000k	50		10m
HF1615SB.15.65K	24	15	6500k	50		10m



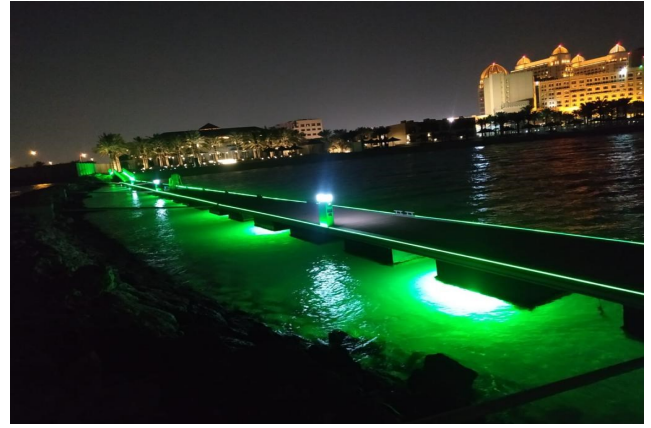
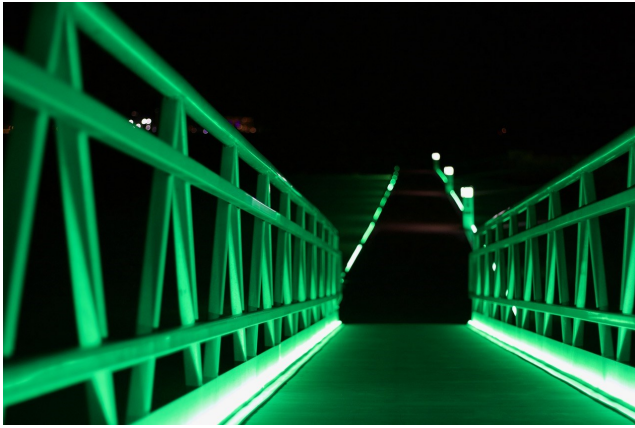

**SINGLE COLOUR**  
**BLUE | GREEN | RED**



CODE	V	W	COLOUR	CUT (mm)	Lm/m	MAX
HFP1615SB.5.BL	24	5	BLUE	50	57	25m
HFP1615SB.5.GR	24	5	GREEN	50	308	25m
HFP1615SB.5.RD	24	5	RED	50	112	25m

CODE	V	W	COLOUR	CUT (mm)	Lm/m	MAX
HFP1615SB.72.BL	24	7.2	BLUE	50	82	20m
HFP1615SB.5.GR	24	7.2	GREEN	50	444	20m
HFP1615SB.5.RD	24	7.2	RED	50	162	20m

CODE	V	W	COLOUR	CUT (mm)	Lm/m	MAX
HFP1615SB.10	24	10	BLUE	50	107	15m
HFP1615SB.10	24	10	GREEN	50	548	15m
HFP1615SB.10	24	10	RED	50	238	15m

CODE	V	W	COLOUR	CUT (mm)	Lm/m	MAX
HFP1615SB.15	24	15	BLUE	50	149	12m
HFP1615SB.15	24	15	GREEN	50	697	12m
HFP1615SB.15	24	15	RED	50	323	12m



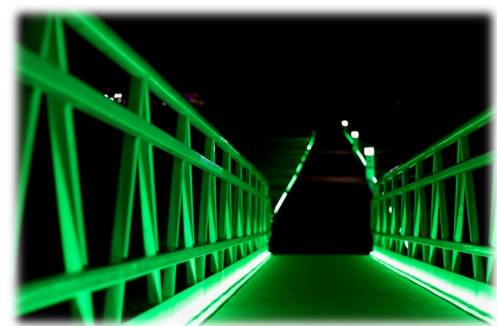

HFP1615SB.PCS  
Power cord side

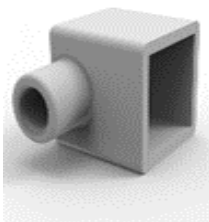

HFP1615SB.PCE  
Power cord end

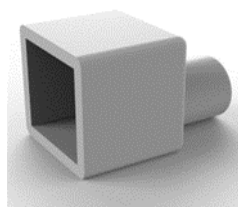

HFP1615SB.PCEC

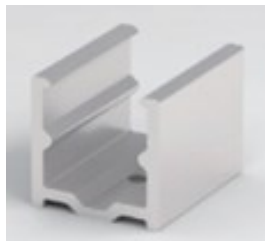
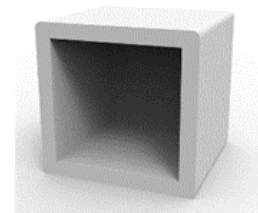

HFP1615SB-MCU  
Fixing clip



HFP1615SB-MCF  
Fixing channel bendable

